



ColorMix

Lighting Solutions by **Allanson**

Smartphone
Tablet

WiFi LED Controller



ACL-T3-RC



ACL-WIFI-103

Model: ACL-WIFI-103



WiFi-103 is a WiFi lighting control system, consists of APPs and WiFi controller. Controls various types of LED lighting products by installing the related APP on our iOS or Android mobile devices which support WiFi connection. Supports connection directly or by router.

Dim, CT adjustment, RGB changing 3 in 1 operation, plus DIY programable function. Compatible with T3 RF work.

1. Product Parameter:

WiFi-103 Technical Parameters:

- Communication Standard: 2.4GHz Wi-Fi, 802, 11b/g/n Protocol
- Input Voltage: 12 or 24Vdc
- Max Current Load: 5A or 4A DC
- Max Output Power: 4A per channel
- Output Control: Single Color, CT, RGB LEDs
- Control Distance: Max 100m
- RGB Change Mode: 32 Fixed Modes, 8 DIY Modes
- Scene Mode: RGB 9 Modes, CT 3 Modes
- Operating Temp.: -30 °C ~55 °C
- Dimensions: L128×W73×H45(mm)
- Package Size: L135×W80×H50(mm)
- Weight (G.W): 320g

Software Technical Parameters:

- Platform: Android 2.1 or Above, iOS 5.1 or Above, With the WiFi Function
- Size: Android (1.8MB), iOS (5.6MB)
- Language: English
- Category: Tool
- Others: Free, No Plug-ins

2. Configuration Diagram:

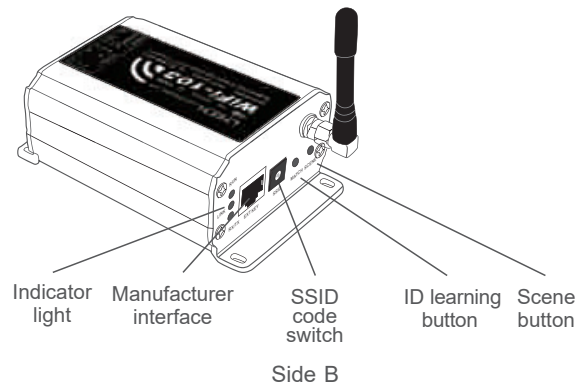
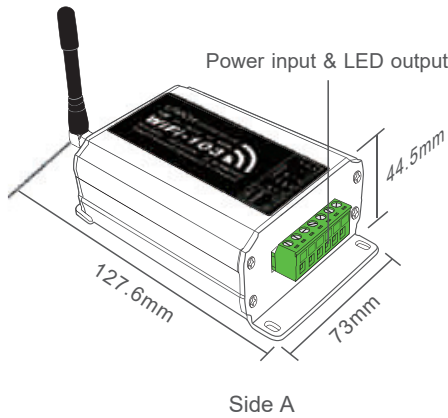

3. Controller Operating Instructions:

3.1 Install/Uninstall ANT:

Clockwise to install the WiFi-103 ANT, counterclockwise to take off.

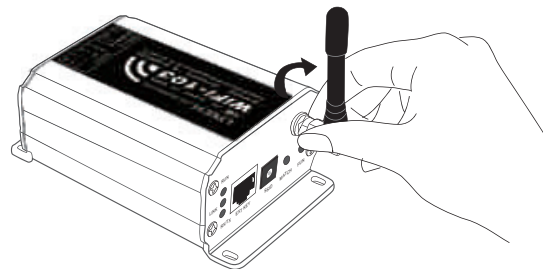

3.2 Work Status Indicator Instructions:

RUN: The indicator light flashes quickly about 25s during the electric initialization. Flashes once per second after initialization finished.

LINK: The indicator light stays lit when the mobile device connects to WiFi-103, and turns off when disconnect.

RX/TX: The indicator light turns on when WiFi-103 receives or transmits the WiFi data. Turns off in the free time.

SSID Number Setting:

Use code switch to set the controller's SSID Number, WiFi-103-SSID-X, X stands for a certain No. ranging from 0-F, totally 16 options. which means our product could set 16 isolated LAN in the same area. WiFi-103 will initialize with run LED indicator flashing about 25s quickly, each time the SSID NO. is changed. Mobile devices need to search and connect WiFi again after Initialization finished.

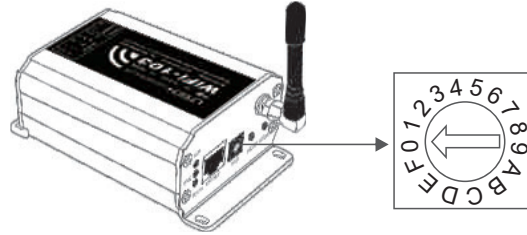

3.4 "Match" Button and "Scene" Button:

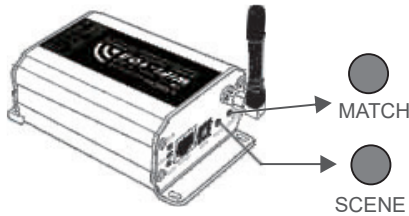

Short press "SCENE" button to enter DIY scenes sequentially, scene mode changes from 1 to 9 then backwards.



RGB scene interface



CT scene interface

[Restore Factory Settings]

Long press "MATCH" button and "SCENE" button simultaneously more than 2 seconds, the machine will back to the default parameter, including the parameters of changing modes, and network parameters, WiFi-103 controller restore as directly connect.

4. The Instructions of APP Software:

4.1 WiFi-103 Software Installation:

Scan following QR code to download and install.



iOS/Android

4.2 Software Operating Instructions

4.2.1 Network Connection Setting

WiFi-103 support 2 modes: Direct connection as router or connect by additional router.

• WiFi-103 Controller Direct Connection as Router :

Enter mobile device's WiFi setting, click the WiFi function, mobile device search and list the working WiFi controller automatically (As Figure-1), Click the SSID number to connect (default is no password).

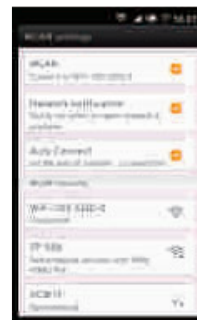

Android WiFi connection





Apple WiFi connection

(Figure-1)

• **Connection with an Additional Router:**

Connect WiFi-103 Controller to The Additional Router Network:

- A. Connect to the WiFi-103 controller, the same step as (4.2.1)
- B. Click mobile device's icon  to start the software, the software will search and list the working WiFi controller automatically, and there is a blue wireless icon  (as Figure-2-1)

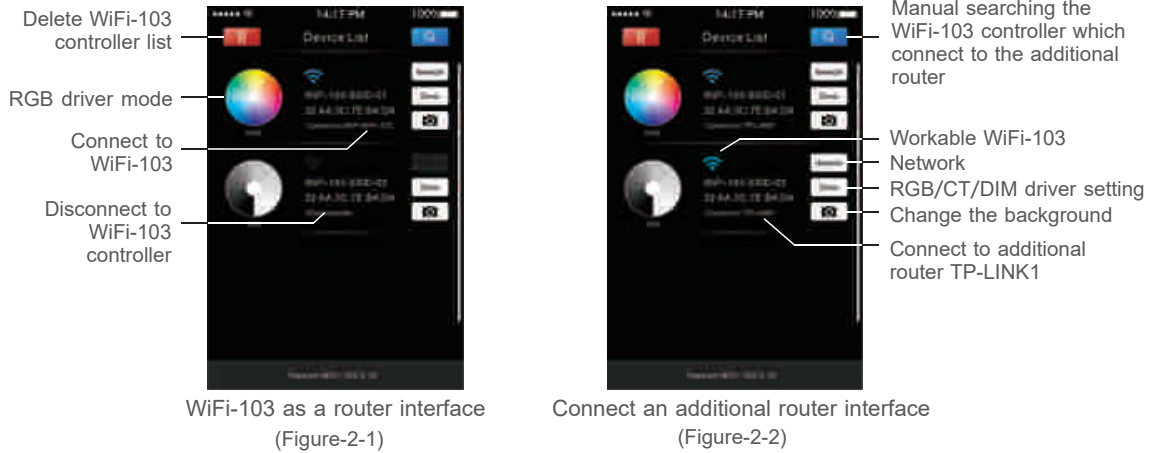

- C. Click "Network" key to enter Network interface(as Figure-3-1), start "connect to exiting LAN", software will search the workable WiFi net SSID list, choose the specified router to connect (Attn: do not choose WiFi-103 controller), can add the WiFi-103 controller to the wireless router(as Figure-3-2 the wireless router TP-LINK1)

Repeat the ABC steps if you need connecting multiple WiFi-103 controller to this wireless router.

- D. Exit WiFi-103 software, enter mobile device setting-wireless network setting, choose the wireless router to connect. Device List interface shows as Figure-2-2 when re-open the WiFi-103 software. Completes the steps to connect to the additional router.



(Figure-3-1)

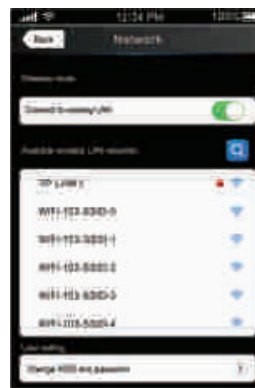

(Figure-3-2)

Attn: In this connection mode, to avoid the mobile device automatically connect to WiFi-103 after the setting has completed, please click on the connected WiFi-103 which under the mobile device "WiFi setting" and at the message box please click "Forget this network" (apple iOS) or "Cancel save" (SAMSUNG mobile phone is "forget") to cancel the save of WiFi-103 connection.



Android cancellation of the save of WiFi-103 connection

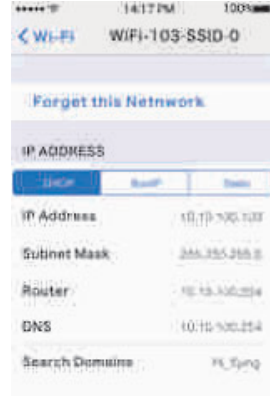

Apple cancellation of the save of WiFi-103 connection

4.2.2 RGB/CT/DIM Driver Color Wheel Interface:

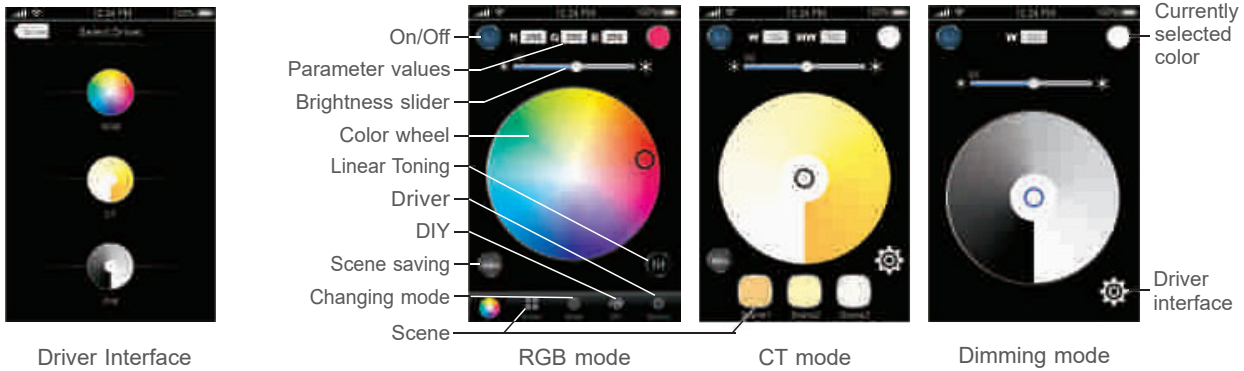

4.2.3 RGB Linear Toning Interface  :

Click  to enter linear toning interface in the RGB mode with color wheel.

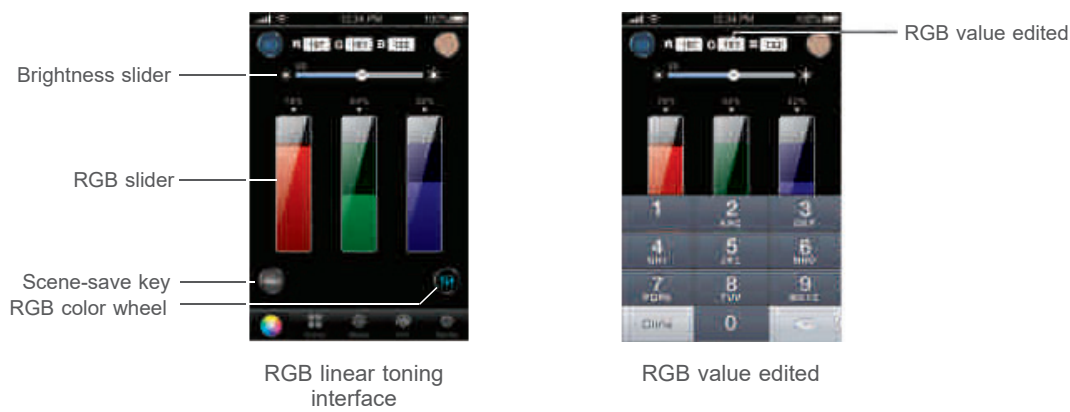

4.2.4. RGB Scene Interface

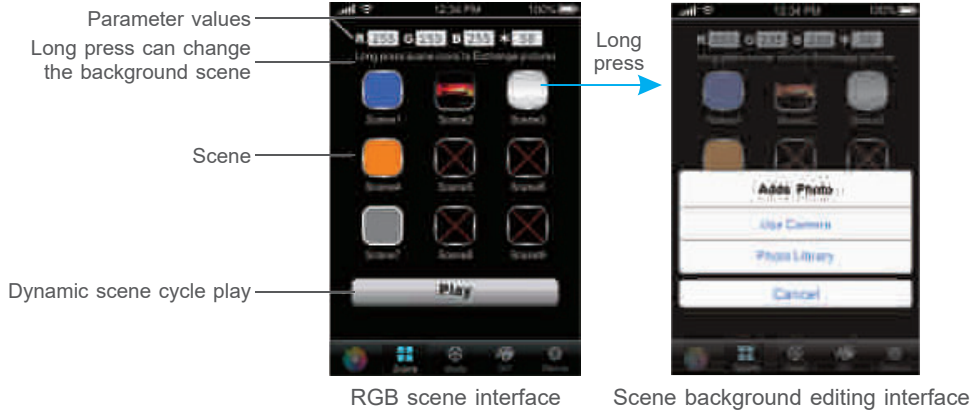

4.2.5 RGB Save Scene Interface

On the interface of RGB color wheel, linear toning, and mode or DIY, click  to the scene-save interface.



4.2.6 CT Mode Interface

On CT interface, select color temperature by touching color wheel, then click , scene 1~3 start flash, select any one, the scene name box will pop-up, you can rename the scene. Click "OK" to save the current color temperature as a scene; click "cancel" to cancel the save operation.

After save, select any scene from 1~3 in the CT interface, the corresponding scene changing mode will pop-up immediately.

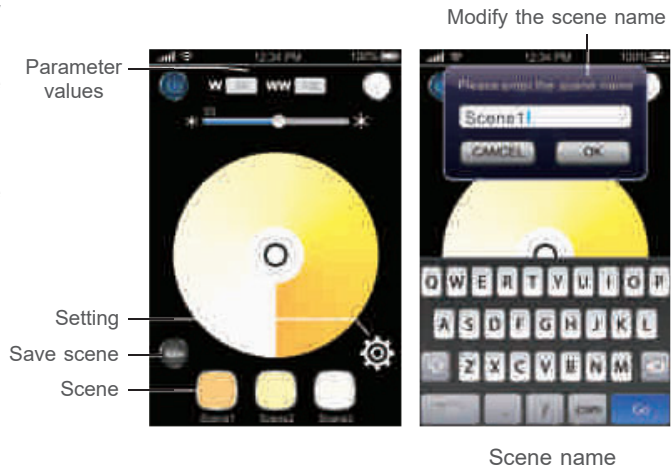

4.2.7 RGB Mode Interface  Mode :

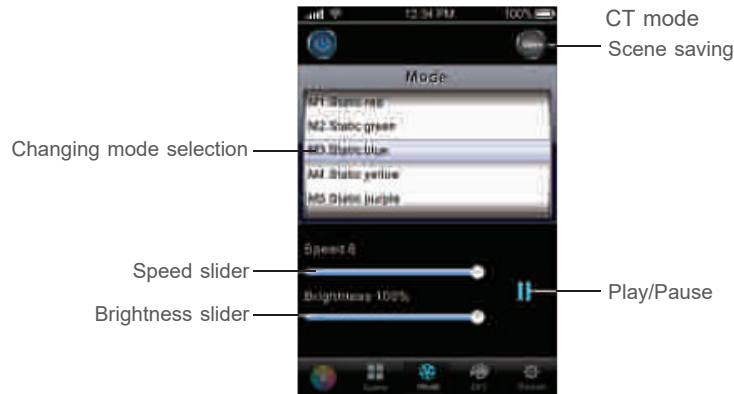

Mode interface

Tables of Changing Mode:

No.	Mode	No.	Mode
1	Static Red	17	Cyan Fade Out and Fade In
2	Static Green	18	White Fade Out and Fade In
3	Static Blue	19	RGB Fade Out and Fade In
4	Static Yellow	20	Red/Green Gradual Alternately
5	Static Purple	21	Red/Blue Gradual Alternately
6	Static Cyan	22	Green/Blue Gradual Alternately
7	Static White	23	Red/Yellow Gradual Alternately
8	RGB Jumping	24	Green/Cyan Gradual Alternately
9	7 Colors Jumping	25	Blue/Purple Gradual Alternately
10	White Strobe	26	Green/Yellow Gradual Alternately
11	7 Colors Strobe	27	Blue/Cyan Gradual Alternately
12	Red Fade Out and Fade In	28	Red/Purple Gradual Alternately
13	Green Fade Out and Fade In	29	Blue/White Gradual Alternately
14	Blue Fade Out and Fade In	30	Yellow/Purple/Cyan Gradual Alternately
15	Yellow Fade Out and Fade In	31	RGB Gradual Alternately
16	Purple Fade Out and Fade In	32	Full Color Gradual Alternately

Comment: Speed/Brightness Adjustable

4.2.8 DIY Interface

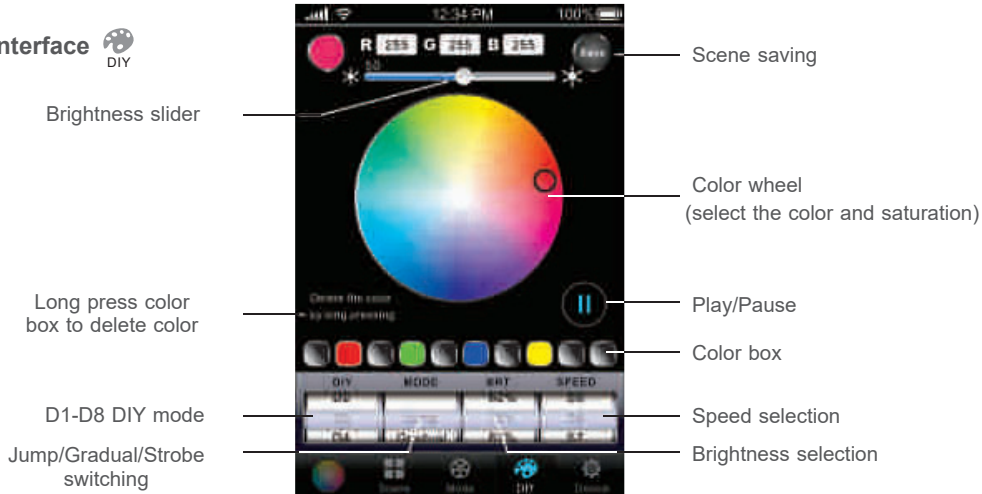

DIY interface

For Example:

The sequence for 10 color boxes is black, red, black, green, black, blue, black, yellow, black, black, which means 8 colors was chosen in the above boxes, which is black, red, black, green, black, blue, black, yellow. For jump type, this lighting effect will be red, green, blue, yellow 4 colors strobe. For gradual type, this lighting effect will be red fade-in and fade-out, green fade-in and fade-out, blue fade-in and fade-out, yellow fade-in and fade-out.



5. WiFi Network SSID Name and Password Setting

In Device List interface, click “Network” key to enter Network interface, select “Change SSID and Password” (Click “⊗”) to enter User Setting interface. Typing new SSID name and password (Min. 8 characters, consist of 0-9, a-z and A-Z). Click “Apply” key on the top right corner of the interface to save the changes.

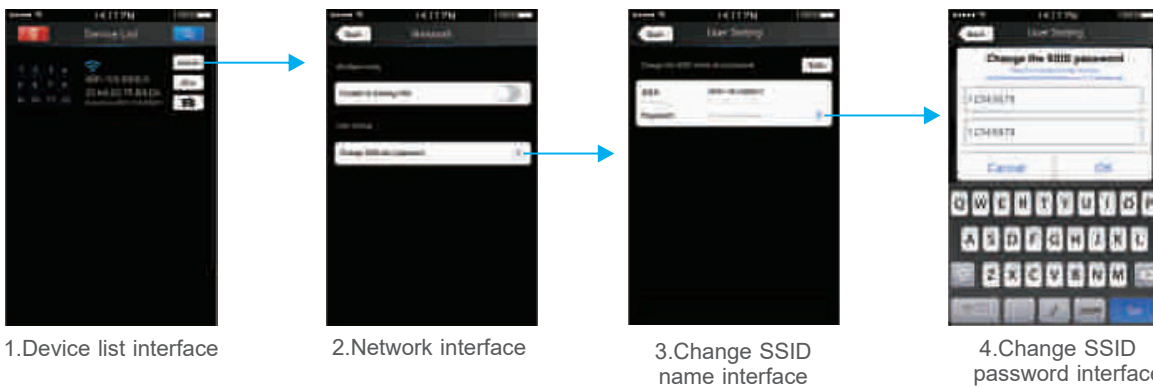

[Attn]: In direct connection of the WiFi-103 as a router. Please exit software after changed the SSID name and the password, then enter the mobile device system setting to reconnect the WiFi-103, In additional wireless router connection, it only needs to click “” in Device List interface to search again the WiFi-103 controller after changed SSID name.

[Attn]: If you forget the WiFi network password, please simultaneously press “MATCH” button and “SCENE” button more than 2s to restore the factory default settings, so that can delete the WiFi network password (More details in page 3 [Restore factory settings])

6. The Remote Operating Instructions

ACL-T3-RC Technical Parameters:

- | | |
|-----------------------------|---------------------------------|
| • Charging Voltage: 5Vdc | • Dimensions: L145×W55×H22mm |
| • Working Current: <30mA | • Package Size: L168×W102×H28mm |
| • Working Frequency: 2.4GHz | • Weight (G.W): 235g |
| • RF Remote Distance: 30m | |
| • Battery Capacity: 1000mAh | |
- Note: Remote is sold separately.**

6.1 The Learning Method of ACL-T3-RC to ACL-WIFI-103

Learning ID: Short press ID learning button “MATCH” on WiFi-103, buzzer beep once, long press any key (except “On/Off”) on remote within 5s until the remote indicator light flashes 3 times (meanwhile the buzzer long beep), means the controlling between remote and WiFi-103 is activated.



MATCH Button

Cancelling ID: Long press “MATCH” button on WiFi-103 (over 5s) till the buzzer long beep, means all the remotes learned with WiFi-103 cancelled.

Attn: Different types of remote learning operation, will change WiFi-103 control mode directly (single color, color temperature and RGB mode).

6.2 Function Definition of Remote Control Keys

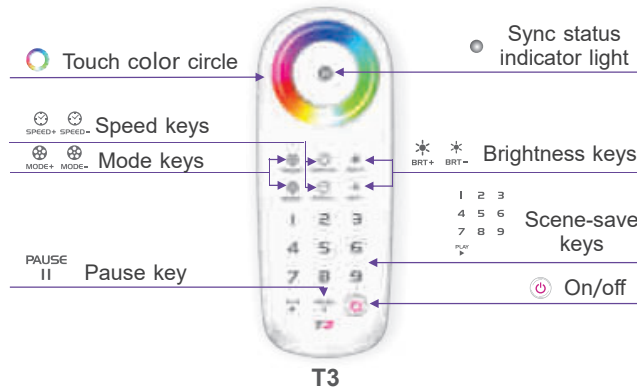

7.1 Setup of Wireless Slave Control :

Method to Sync ACL-T3-RC to ACL-WIFI-103

Learning ID: Long press the “SCENE” button on the WiFi-103 controller until the buzzer long beep (RUN light flash quickly), and then short press the ID learning button on the ACL-T3-RC, the buzzer long beep again. Learning ID successful.



SCENE button

Canceling ID: Long press the “SCENE” button on the WiFi-103 controller until the buzzer long beep twice, cancel all the T3-CV/T3-CC learned with WiFi-103 controller.



7.2 Remote Distance Reference

[Attn]: The following distance is measured at open environment, in unopened environment, testing wireless distance will be reduced. Please refer to the actual test distance before installation.

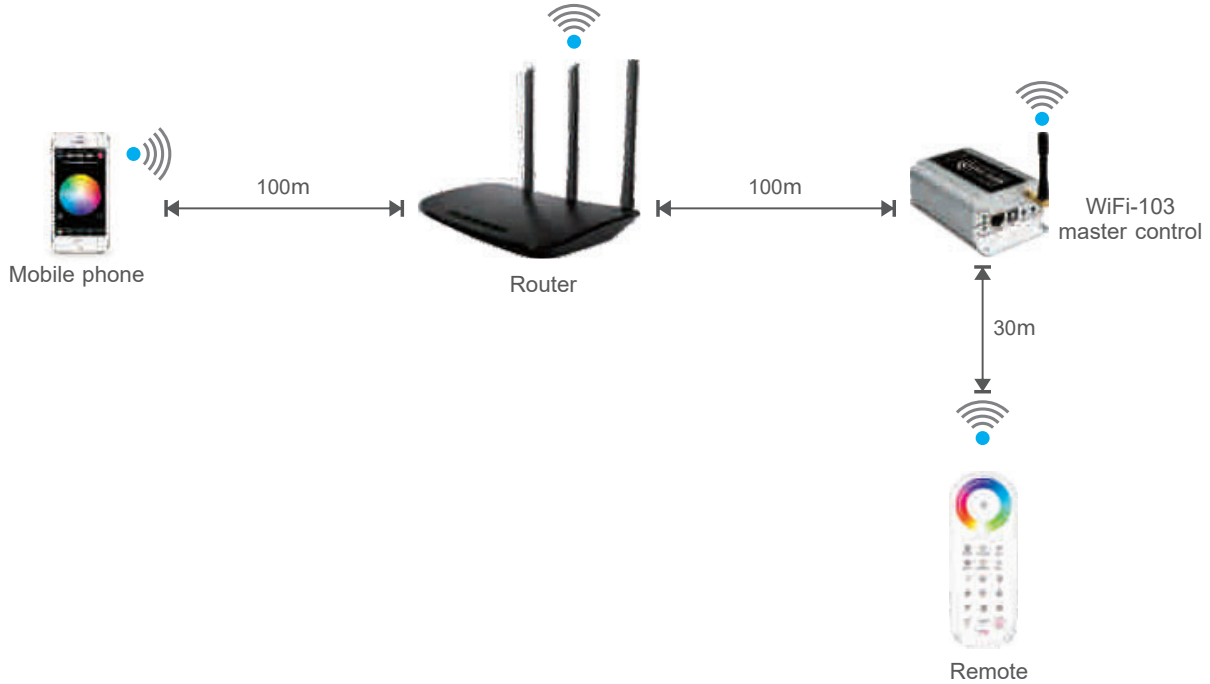

7.3 Wiring Diagrams

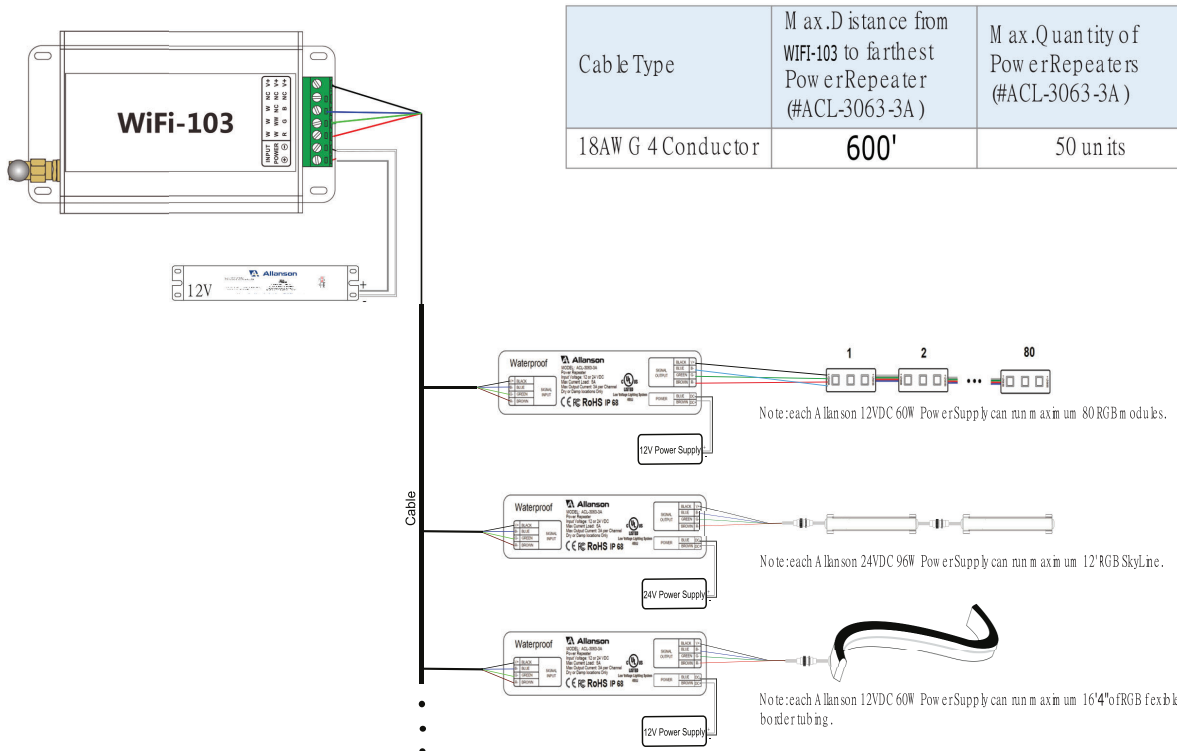

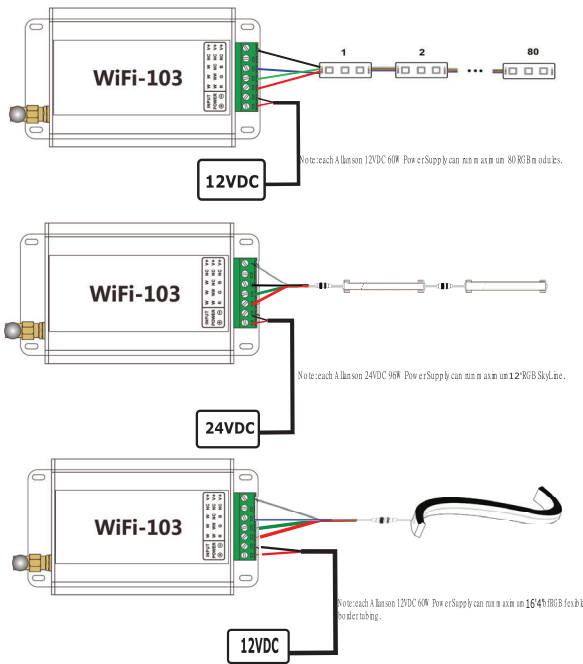

8. Attention

- 8.1 The product shall be installed and serviced by the qualified person.
- 8.2 This product is non-waterproof. Please avoid the sun and rain. When installed outdoors please ensure it is mounted in a water proof enclosure.
- 8.3 Good heat dissipation will prolong the working life of the controller. Please ensure good ventilation.
- 8.4 Please check if the output voltage of the LED power supply used comply with the working voltage of the product.
- 8.5 Please ensure that proper wire gauge is used from the controller to the LED and RGB products to carry the current. Please also ensure that the cable is secured tightly in the connector.
- 8.6 Ensure all wire connections and polarities are correct before applying power to avoid any damages to the LED and RGB products.
- 8.7 If a fault occurs please return the product to your supplier. Do not attempt to fix this product by yourself.

★ This manual only applies to this model. We reserve the right to make changes without prior notice.



www.allanson.com

83 Commerce Valley Dr. E., Markham, ON L3T 7T3 | cservice@allanson.com | 1.800.661.7251